

REVISIONS			
REV	DESCRIPTION	DATE	APPROVED

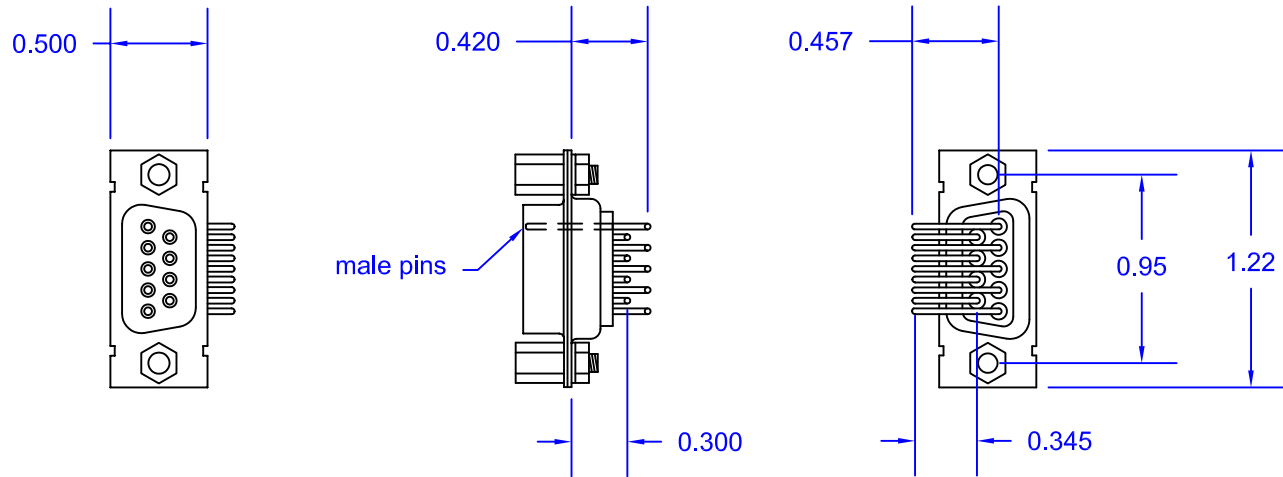

Accu-Glass Products Inc.
 700 Arroyo Ave.
 San Fernando, CA. 91340
 TEL. 818-365-4215
 FAX. 818-365-7074

Notes :

*** UNCONTROLLED WEB COPY ***

Material		Title		
Tolerances unless otherwise specified		9D-HVPCBP		
Decimal	Angular	Drawn By	M.Wilson	DWG NO. 111100
.xx= +/- .005	+/- 1°	Approved		Date 1-30-08
.xxx= +/- .002				Cage Code : 4HCQ8