

- NOTES : 1. B Dim. not needed for flanges / plates less than .500 thick.
 2. Space required between connectors : 50 pin = .250
 3. Flanges .700" thick or larger Contact Accu-Glass Products Inc.

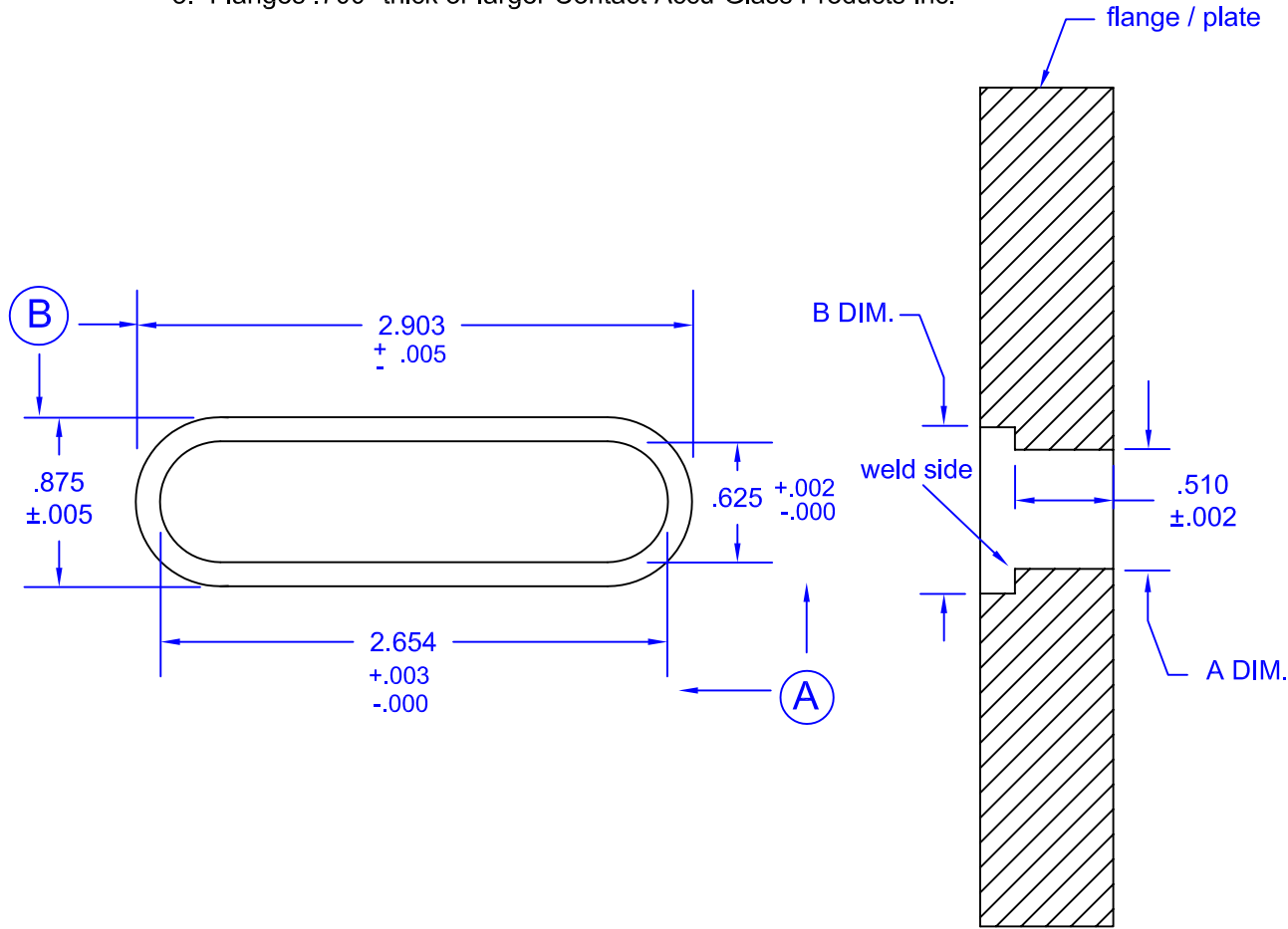

REVISIONS			
REV	DESCRIPTION	DATE	APPROVED

- 1 4-40 UNC Thread Both sides.
- 2 0.040 Pin Dia TYP.

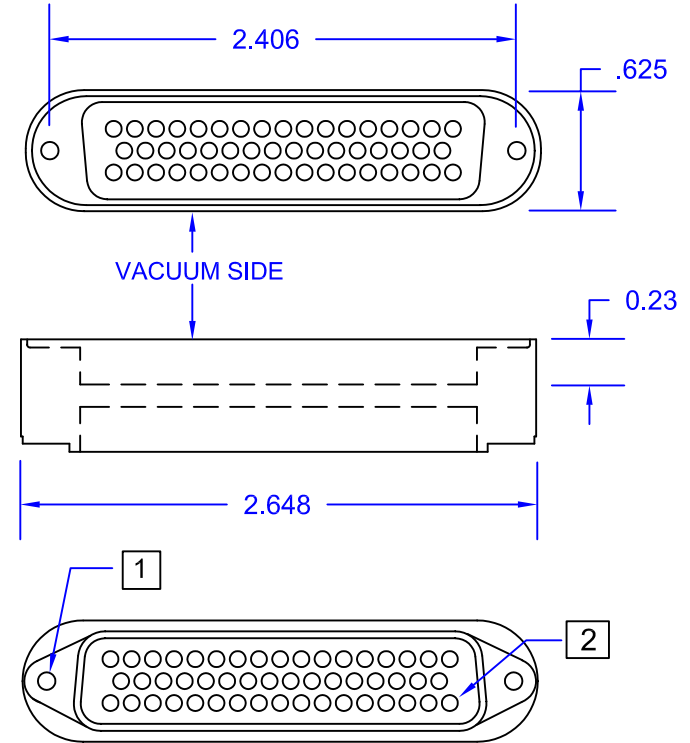

Accu-Glass Products Inc.
 700 Arroyo Ave.
 San Fernando, CA. 91340
 TEL. 818-365-4215
 FAX. 818-365-7074

Notes :

*** UNCONTROLLED WEB COPY ***

Material 304 SS	
Tolerances unless otherwise specified	
Decimal	Angular
.xx= +/- .005	+/- 1°
.xxx= +/- .002	

Title 50 Pin Sub-D Feedthrough			
Drawn By	M.Wilson	DWG NO.	EAG-50D
Approved			Date 7-12-07
			Cage Code : 4HCQ8