

- NOTES :
- 1. B Dim. not needed for flanges / plates less than .500" thick.
  - 2. Space required between connectors : 5 pin coaxial D-Type = .250
  - 3. Flanges .700" thick or larger Contact Accu-Glass Products Inc.
  - 4. Flange / plate material: 304 or 316 Stainless Steel

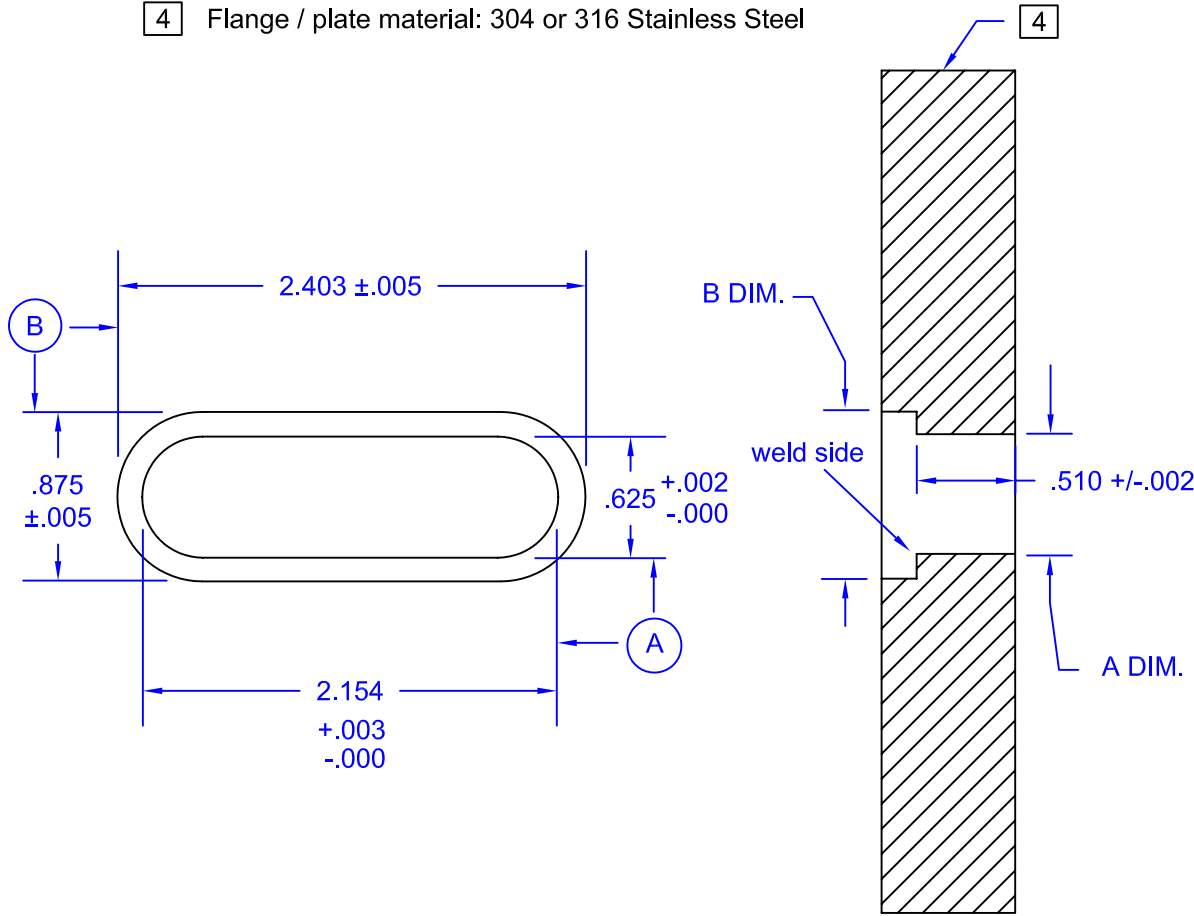

REVISIONS			
REV	DESCRIPTION	DATE	APPROVED

- 1 4-40 UNC Thread 4 plcs.
- 2 0.153 Dia TYP. body conductor
- 3 0.040 Pin Dia TYP. center conductor

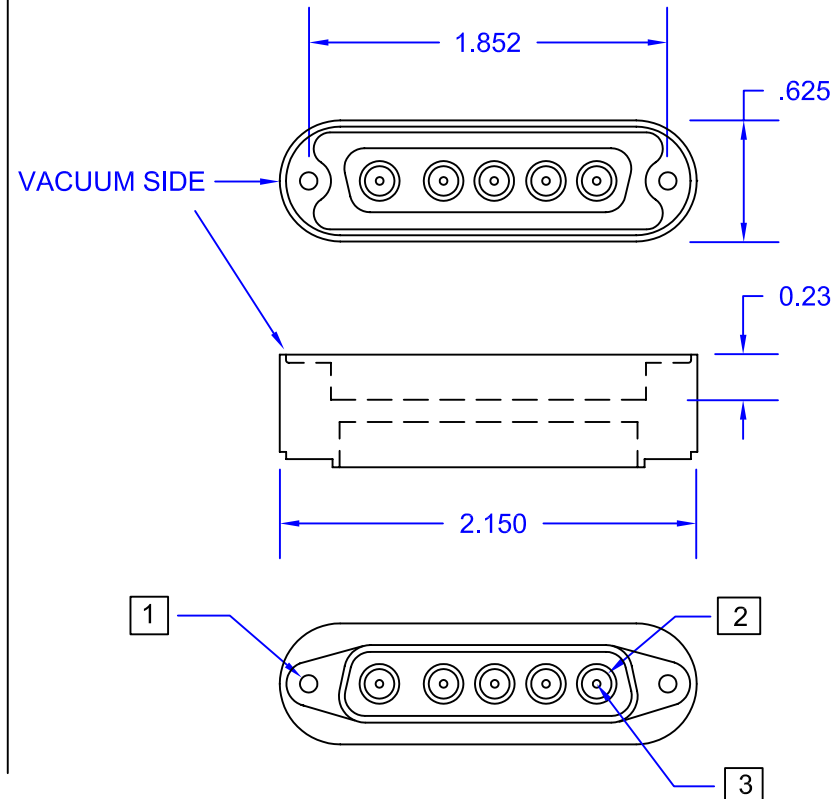

Accu-Glass Products Inc.  
700 Arroyo Ave.  
San Fernando, CA. 91340  
TEL. 818-365-4215  
FAX. 818-365-7074

Notes :

**\* UNCONTROLLED WEB COPY \***

Material  
**304 Stainless Steel**

Tolerances unless otherwise specified  
Decimal Angular  
.xx= +/- .005 +/- 1°  
.xxx= +/- .002

Title  
**5 Pin Coaxial Sub-D Feedthrough**

Drawn By	M. Wilson	DWG NO.	EAG-5CX	Date	1-3-97
Approved				Cage Code : 4HCQ8	